

TECHNICAL DATA

Power	3 - 7,5 W
Operating voltage	24 V DC
Type of luminaire	Light strip
LED Type	SMD
Control	PWM
Light efficiency	up to 106 lm/W
Colour consistency	SDCM3
Lifetime	L80 B10 60.000 h @ 10°C L80 B10 50.000 h @ 25°C
Ambient temperature	-30°C to +25°C
Material	Aluminium
Cascading	yes
Warranty	5 Years



Further information on the control gear can be found in the installation instructions belonging to this product.



TYPES

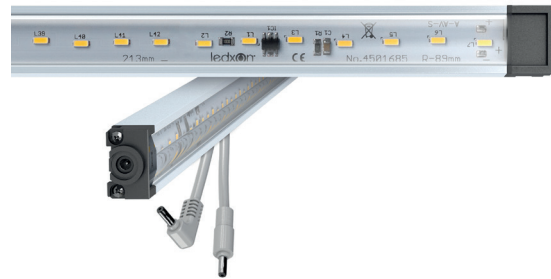

DIMENSIONS (mm)

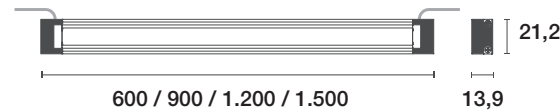

BEAM ANGLE

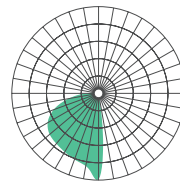

HIGHLIGHTS

- cost effective retrofit system
- especially for refrigerated cabinets -30° to +25° (IP 44)
- Flexible integration with multiple accessories
- brilliant light with CRI 94
- Installation: via magnet or screw clip
- Splash water protected socket connectors (both sides)

APPLICATIONS SCL-G2-ASYM

Mounting at the bottom of the shelf, for illumination of the shelves.

- Refrigerated multideck cabinet (open / closed)
- Freezer and Combi Freezer
- semi-verticals

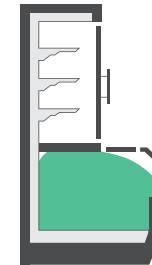
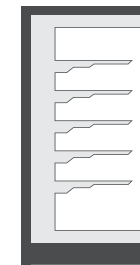

Attachment to the handrail or to the tub

STANDARDS SCL-SERIES

IEC 60598-1-2014

IEC 60598-1-2014/AMD1:2017

IEC 60598-2-1-2020

IEC 60335-1-2010

IEC 60335-1-2010/AMD1:2013

IEC 60335-1-2010/AMD2:2016

IEC 60335-2-89:2010

IEC 60335-2-89:2010/AMD1:2012

IEC 60335-2-89:2010/AMD2:2015

Item number	Productcode	Power	Light colour Ledxon	CRI	Luminous flux	Beam characteristic	Length	Casca- ding	Weight
9100870	SCL-G2-L600-930-ASYM-B	3 W	3000 K	94	305 lm	Shelf edge / asymmetrical	578 mm	24	0,21 kg
9100871	SCL-G2-L600-940-ASYM-B	3 W	4000 K	94	318 lm	Shelf edge / asymmetrical	578 mm	24	0,21 kg
9100872	SCL-G2-L600-957-ASYM-B	3 W	5700 K	94	318 lm	Shelf edge / asymmetrical	578 mm	24	0,21 kg
9100873	SCL-G2-L600-FM-ASYM-B	3 W	Fresh meat	90	244 lm	Shelf edge / asymmetrical	578 mm	24	0,21 kg
9100874	SCL-G2-L900-930-ASYM-B	4,5 W	3000 K	94	457 lm	Shelf edge / asymmetrical	890 mm	16	0,30 kg
9100875	SCL-G2-L900-940-ASYM-B	4,5 W	4000 K	94	476 lm	Shelf edge / asymmetrical	890 mm	16	0,30 kg
9100876	SCL-G2-L900-957-ASYM-B	4,5 W	5700 K	94	476 lm	Shelf edge / asymmetrical	890 mm	16	0,30 kg
9100877	SCL-G2-L900-FM-ASYM-B	4,5 W	Fresh meat	90	367 lm	Shelf edge / asymmetrical	890 mm	16	0,30 kg
9100878	SCL-G2-L1200-930-ASYM-B	6 W	3000 K	94	610 lm	Shelf edge / asymmetrical	1196 mm	12	0,41 kg
9100879	SCL-G2-L1200-940-ASYM-B	6 W	4000 K	94	635 lm	Shelf edge / asymmetrical	1196 mm	12	0,41 kg
9100880	SCL-G2-L1200-957-ASYM-B	6 W	5700 K	94	635 lm	Shelf edge / asymmetrical	1196 mm	12	0,41 kg
9100881	SCL-G2-L1200-FM-ASYM-B	6 W	Fresh meat	90	489 lm	Shelf edge / asymmetrical	1196 mm	12	0,41 kg
9100882	SCL-G2-L1500-930-ASYM-B	7,5 W	3000 K	94	762 lm	Shelf edge / asymmetrical	1482 mm	9	0,51 kg
9100883	SCL-G2-L1500-940-ASYM-B	7,5 W	4000 K	94	794 lm	Shelf edge / asymmetrical	1482 mm	9	0,51 kg
9100884	SCL-G2-L1500-957-ASYM-B	7,5 W	5700 K	94	794 lm	Shelf edge / asymmetrical	1482 mm	9	0,51 kg
9100885	SCL-G2-L1500-FM-ASYM-B	7,5 W	Fresh meat	90	611 lm	Shelf edge / asymmetrical	1482 mm	9	0,51 kg

TECHNICAL DATA

Power	13,2 - 18 W
Operating voltage	24 V DC
Type of luminaire	Light strip
LED Type	SMD
Control	Bluetooth
Light efficiency	up to 100 lm/W
Colour consistency	SDCM3
Lifetime	L80 B10 60.000 h @ 10°C L80 B10 50.000 h @ 25°C
Ambient temperature	-30°C to +25°C
Material	Aluminium
Cascading	no
Warranty	5 Years



Further information on the control gear can be found in the installation instructions belonging to this product.



TYPES

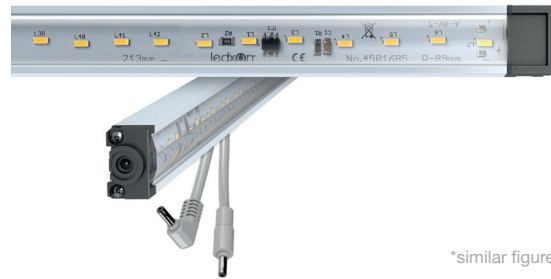

*similar figure

DIMENSIONS (mm)

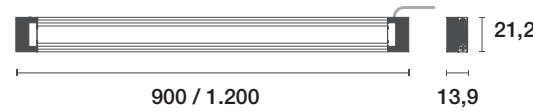

BEAM ANGLE

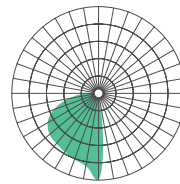

HIGHLIGHTS

- no WLAN necessary
- Mesh-function
- timer
- group function
- scenes
- password protected
- no additional dimmer necessary

APPLICATIONS SCL-G2-ASYM

Mounting at the bottom of the shelf, for illumination of the shelves.

- Refrigerated multideck cabinet (open / closed)
- Freezer and Combi Freezer
- semi-verticals

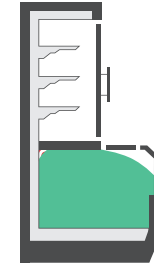
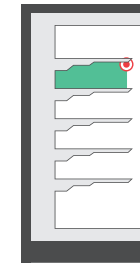

Attachment to the handrail or to the tub

LIGHTMANAGEMENT

Download our App: **eyeconex LIGHTMANAGEMENT**

- lighting control via Bluetooth

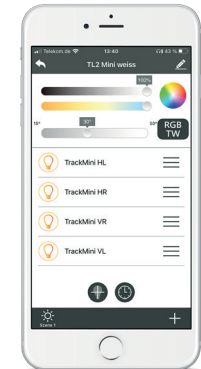

Item number	Productcode	Power	Light colour Ledxon	CRI	Luminous flux	Beam characteristic	Length	Weight
9100949	SCL-G2-L900-940-FM-ASYM-BT	13,2 W	4000 K - Fresh meat	94	1250 lm	Handrail / Counter asymmetrical / Shelf edge / asymmetrical	906 mm	0,36 kg
9100950	SCL-G2-L1200-940-FM-ASYM-BT	18 W	4000 K - Fresh meat	94	1700 lm	Handrail / Counter asymmetrical / Shelf edge / asymmetrical	1212 mm	0,47 kg
9100954	SCL-G2-L900-927-957-ASYM-BT	13,2 W	2700 K - 5700 K	94	1300 lm	Handrail / Counter asymmetrical / Shelf edge / asymmetrical	906 mm	0,36 kg
9100955	SCL-G2-L1200-927-957-ASYM-BT	18 W	2700 K - 5700 K	94	1800 lm	Handrail / Counter asymmetrical / Shelf edge / asymmetrical	1212 mm	0,47 kg

ACCESSORIES

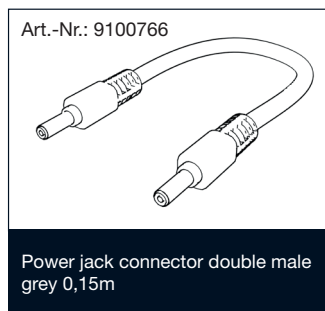
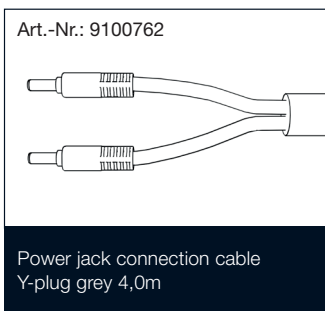
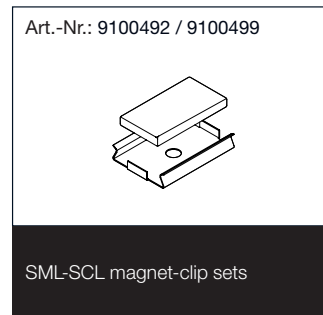
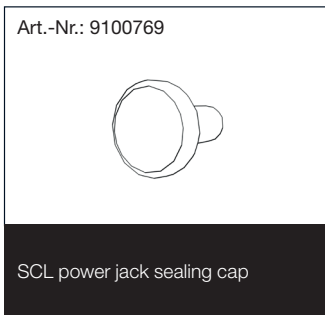
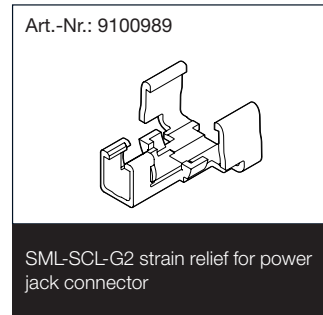
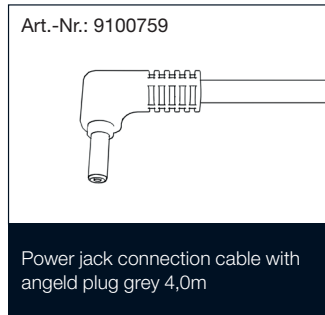
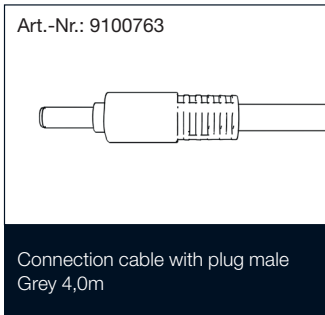

itembezeichnung	Item number
Connection cable with plug male grey 4,0m (for LCR-SCL-SML)	9100763
Power jack connection cable with angled plug grey 4,0m (for LCR-SCL-SML)	9100759
Power jack connection cable female grey 4,0m (for LCR-SCL-SML)	9100764
Power jack connector double male grey 0,15m (for LCR-SCL-SML)	9100766
Power jack connection cable Y-plug grey 4,0m (for LCR-SCL-SML)	9100762
Power jack end cap grey (for LCR-SCL-SML)	9100769
SML-SCL-G2 strip connector	9100791
SML-SCL clip adjustable set of 2 / 0-90° (for L450, L600, L900, L1200)	9100497
SML-SCL clip adjustable set of 3 / 0-90° (for L1500)	9100498
SML-SCL Magnet-Clip set of 2 (for L450, L600, L900, L1200)	9100492
SML-SCL Magnet-Clip set of 3 (for L1500)	9100499
Strip lock for connection cable male/female set of 2 (for LCR-SCL-SML)	9100780
SML-SCL-G2 strain relief for power jack connector	9100989

IMPORTANT NOTES

All technical parameters apply to the entire product. Due to the complex manufacturing process of light emitting diodes, the specified typical LED parameters are only purely statistical values and may deviate.

The specified type of use must be strictly adhered to. Deviations may affect the stability of the fixture. Please observe the information in the mounting instructions before using the products.

The specified type of use must be observed. Deviations may affect the stability of the fastening. Before using the products, please observe the notes in the installation instructions.

Mercury content	0,0 mg
Mercury-free	yes
Professional disposal according to WEEE	yes

NOTES TO THE LIFE TIME

Decisive factors for the life time are the ambient temperature and the operating temperature (Tc). Exceeding the permissible limits results in a substantial reduction of the life time and can even lead to the destruction of the products. The specified life time represents a statistical quantity.

NOTES TO ELECTRICAL AND PHOTOMETRIC DATA

Colour coordinates according to CIE 1931

Rated ambient temperature: $t_a = 25^\circ$

Measuring tolerance colour coordinates (x/y) +/- 0,005

Tolerance range of electrical / photometric data: +/- 10%

DISCLAIMER

Changes and errors excepted. Due to the continuous development of all products, technical and design changes can occur at any time. Make sure that you always use the latest version of the data sheet.

WARRANTY NOTES

Please refer to our warranty conditions on:

<https://www.ledxon.de/en/guarantee/>

Further product data as well as current information can be found at www.ledxon.com

5 YEARS
WARRANTY

