

## TECHNICAL DATA

<b>Power</b>	6,6 - 15W
<b>Operating voltage</b>	24 V DC
<b>Type of luminaire</b>	Light strip
<b>LED Type</b>	SMD
<b>Control</b>	PWM
<b>Light efficiency</b>	up to 102 lm/W
<b>Colour consistency</b>	SDCM3
<b>Lifetime</b>	L80 B10 60.000 h @ 10°C L80 B10 50.000 h @ 25°C
<b>Ambient temperature</b>	-30°C to +25°C
<b>Material</b>	Aluminium
<b>Cascading</b>	yes
<b>Warranty</b>	5 Years



Further information on the control gear can be found in the installation instructions belonging to this product.



## TYPES

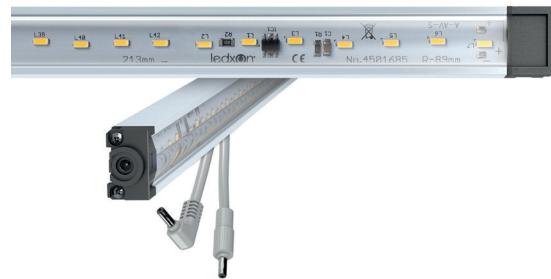

## DIMENSIONS (mm)

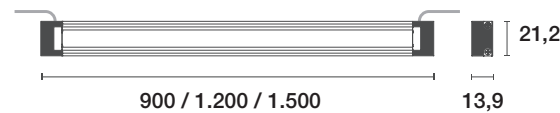

## BEAM ANGLE

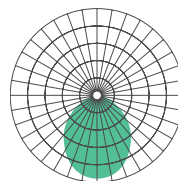

## HIGHLIGHTS

- cost effective retrofit system
- especially for refrigerated cabinets -30° to +25° (IP 44)
- Flexible integration with multiple accessories
- brilliant light with CRI 94
- Installation: via magnet or screw clip
- Splash water protected socket connectors (both sides)

## APPLICATIONS SCL-G2-SYM

Mounting at the bottom of the shelf, for illumination of the shelves.

- Refrigerated multideck cabinet (open / closed)
- Freezer and Combi Freezer
- semi-verticals

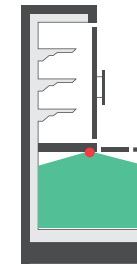

## STANDARDS SCL-SERIES

IEC 60598-1-2014

IEC 60598-1-2014/AMD1:2017

IEC 60598-2-1-2020

IEC 60335-1-2010

IEC 60335-1-2010/AMD1:2013

IEC 60335-1-2010/AMD2:2016

IEC 60335-2-89:2010

IEC 60335-2-89:2010/AMD1:2012

IEC 60335-2-89:2010/AMD2:2015

Item number	Productcode	Power	Light colour Ledxon	CRI	Luminous flux	Beam characteristic	Length	Casca- ding	Weight
9100838	SCL-G2-L900-940-SYM-B	9 W	4000 K	94	901 lm	Counter - Shelf center / symmetrical	890 mm	8	0,26 kg
9100839	SCL-G2-L900-930-SYM-B	9 W	3000 K	94	820 lm	Counter - Shelf center / symmetrical	890 mm	8	0,26 kg
9100975	SCL-G2-L900-FM-SYM-B	6,6 W	Fresh meat	90	642 lm	Counter - Shelf center / symmetrical	890 mm	10	0,26 kg
9100840	SCL-G2-L900-CP-SYM-B	9 W	Cheese & pastry	94	766 lm	Counter - Shelf center / symmetrical	890 mm	8	0,26 kg
9100841	SCL-G2-L900-FF-SYM-B	9 W	Fresh fish	94	901 lm	Counter - Shelf center / symmetrical	890 mm	8	0,26 kg
9100842	SCL-G2-L1200-940-SYM-B	12 W	4000 K	94	1201 lm	Counter - Shelf center / symmetrical	1196 mm	6	0,35 kg
9100843	SCL-G2-L1200-930-SYM-B	12 W	3000 K	94	1120 lm	Counter - Shelf center / symmetrical	1196 mm	6	0,35 kg
9100976	SCL-G2-L1200-FM-SYM-B	8,8 W	Fresh meat	90	855 lm	Counter - Shelf center / symmetrical	1196 mm	8	0,35 kg
9100844	SCL-G2-L1200-CP-SYM-B	12 W	Cheese & pastry	94	1021 lm	Counter - Shelf center / symmetrical	1196 mm	6	0,35 kg
9100845	SCL-G2-L1200-FF-SYM-B	12 W	Fresh fish	94	1201 lm	Counter - Shelf center / symmetrical	1196 mm	6	0,35 kg
9100846	SCL-G2-L1500-940-SYM-B	15 W	4000 K	94	1502 lm	Counter - Shelf center / symmetrical	1482 mm	4	0,44 kg
9100847	SCL-G2-L1500-930-SYM-B	15 W	3000 K	94	1380 lm	Counter - Shelf center / symmetrical	1482 mm	4	0,44 kg
9100977	SCL-G2-L1500-FM-SYM-B	11 W	Fresh meat	90	1069 lm	Counter - Shelf center / symmetrical	1482 mm	6	0,44 kg
9100848	SCL-G2-L1500-CP-SYM-B	15 W	Cheese & pastry	94	1276 lm	Counter - Shelf center / symmetrical	1482 mm	4	0,44 kg
9100849	SCL-G2-L1500-FF-SYM-B	15 W	Fresh fish	94	1502 lm	Counter - Shelf center / symmetrical	1482 mm	4	0,44 kg

## TECHNICAL DATA

<b>Power</b>	13,2 - 21,6 W
<b>Operating voltage</b>	24 V DC
<b>Type of luminaire</b>	Light strip
<b>LED Type</b>	SMD
<b>Control</b>	Bluetooth
<b>Light efficiency</b>	up to 94 lm/W
<b>Colour consistency</b>	SDCM3
<b>Lifetime</b>	L80 B10 55.000 h @ 10°C L80 B10 45.000 h @ 25°C
<b>Ambient temperature</b>	-30°C to +25°C
<b>Material</b>	Aluminium
<b>Cascading</b>	no
<b>Warranty</b>	5 Years



Further information on the control gear can be found in the installation instructions belonging to this product.



## TYPES

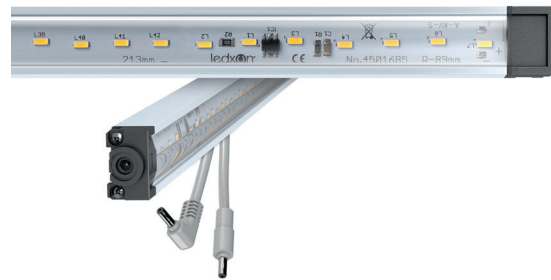

## DIMENSIONS (mm)

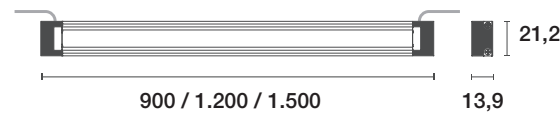

## BEAM ANGLE

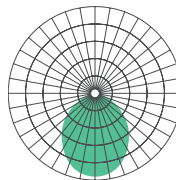

## HIGHLIGHTS

- no WLAN necessary
- Mesh-function
- timer
- group function
- scenes
- password protected
- no additional dimmer necessary

## APPLICATIONS SCL-G2-SYM

Mounting at the bottom of the shelf, for illumination of the shelves.

- Refrigerated multideck cabinet (open / closed)
- Freezer and Combi Freezer
- semi-verticals

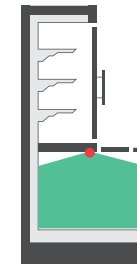

## LIGHTMANAGEMENT

Download our App: **eyeconex LIGHTMANAGEMENT**

- lighting control via Bluetooth

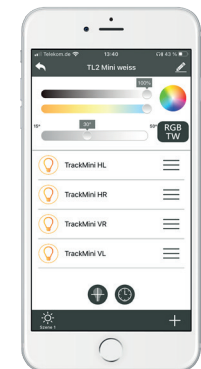

Item number	Productcode	Power	Light colour Ledxon	CRI	Luminous flux	Beam characteristic	Length	Weight
9100942	SCL-G2-L900-CP-FM-SYM-BT	13,2 W	Cheese & pastry - Fresh meat	94	1080 lm	Counter center / Shelf center / symmetrical	906 mm	0,32 kg
9100943	SCL-G2-L1200-CP-FM-SYM-BT	18 W	Cheese & pastry - Fresh meat	94	1480 lm	Counter center / Shelf center / symmetrical	1212 mm	0,42 kg
9100707	SCL-G2-L1500-CP-FM-SYM-BT	21,6 W	Cheese & pastry - Fresh meat	94	1770 lm	Counter center / Shelf center / symmetrical	1482 mm	0,51 kg

## ACCESSORIES

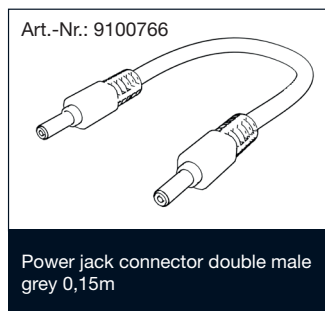
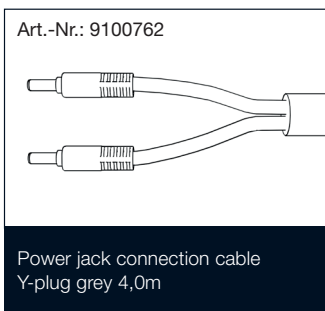
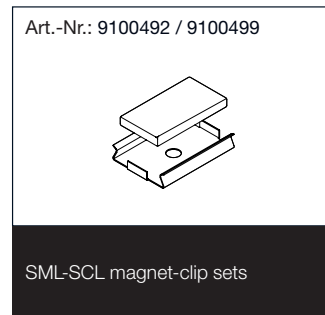
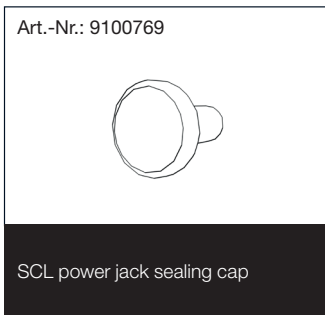
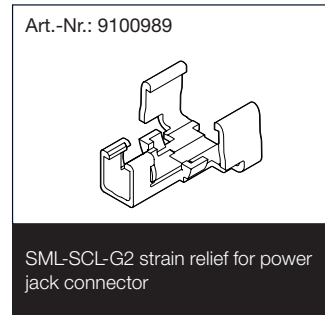
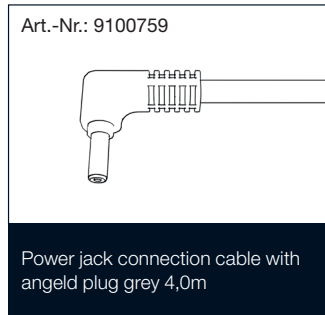
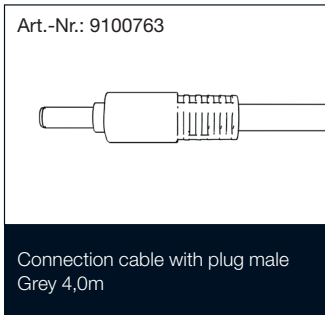

itembezeichnung	Item number
Connection cable with plug male grey 4,0m (for LCR-SCL-SML)	9100763
Power jack connection cable with angled plug grey 4,0m (for LCR-SCL-SML)	9100759
Power jack connection cable female grey 4,0m (for LCR-SCL-SML)	9100764
Power jack connector double male grey 0,15m (for LCR-SCL-SML)	9100766
Power jack connection cable Y-plug grey 4,0m (for LCR-SCL-SML)	9100762
Power jack end cap grey (for LCR-SCL-SML)	9100769
SML-SCL-G2 strip connector	9100791
SML-SCL clip adjustable set of 2 / 0-90° (for L450, L600, L900, L1200)	9100497
SML-SCL clip adjustable set of 3 / 0-90° (for L1500)	9100498
SML-SCL Magnet-Clip set of 2 (for L450, L600, L900, L1200)	9100492
SML-SCL Magnet-Clip set of 3 (for L1500)	9100499
Strip lock for connection cable male/female set of 2 (for LCR-SCL-SML)	9100780
SML-SCL-G2 strain relief for power jack connector	9100989

## IMPORTANT NOTES

All technical parameters apply to the entire product. Due to the complex manufacturing process of light emitting diodes, the specified typical LED parameters are only purely statistical values and may deviate.

The specified type of use must be strictly adhered to. Deviations may affect the stability of the fixture. Please observe the information in the mounting instructions before using the products.

The specified type of use must be observed. Deviations may affect the stability of the fastening. Before using the products, please observe the notes in the installation instructions.

<b>Mercury content</b>	0,0 mg
<b>Mercury-free</b>	yes
<b>Professional disposal according to WEEE</b>	yes

## NOTES TO THE LIFE TIME

Decisive factors for the life time are the ambient temperature and the operating temperature (Tc). Exceeding the permissible limits results in a substantial reduction of the life time and can even lead to the destruction of the products. The specified life time represents a statistical quantity.

## NOTES TO ELECTRICAL AND PHOTOMETRIC DATA

Colour coordinates according to CIE 1931

Rated ambient temperature:  $t_a = 25^\circ$

Measuring tolerance colour coordinates (x/y) +/- 0,005

Tolerance range of electrical / photometric data: +/- 10%

## DISCLAIMER

Changes and errors excepted. Due to the continuous development of all products, technical and design changes can occur at any time. Make sure that you always use the latest version of the data sheet.

## WARRANTY NOTES

Please refer to our warranty conditions on:

<https://www.ledxon.de/en/guarantee/>

Further product data as well as current information can be found at [www.ledxon.com](http://www.ledxon.com)

**5 YEARS**  
WARRANTY

